

BOB BOOKS

Rhyming Words

Book 6: *Lin in the Bin*

1. Picture and Word Matching
2. Bottle Cap Spelling/Writing
3. IN Word Puzzles
4. Word Sorting (IN)
5. Word Hunt
6. Roll a Word
7. Flip a Word
8. Sight Word Search
9. Roll a Sight Word
10. Word Family BINGO

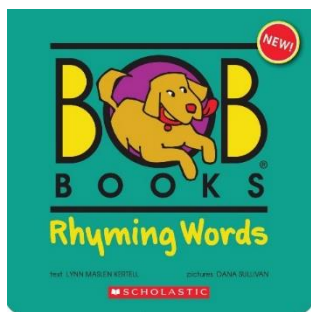

Terms of Use: This printable pack was created for use with your child at home or in the classroom setting. Permission was granted from BOB Books to use their logo.

Created by Becky © www.thisreadingmama.com

©2014 All Rights Reserved.

Directions: Cut apart and match the words with the pictures.

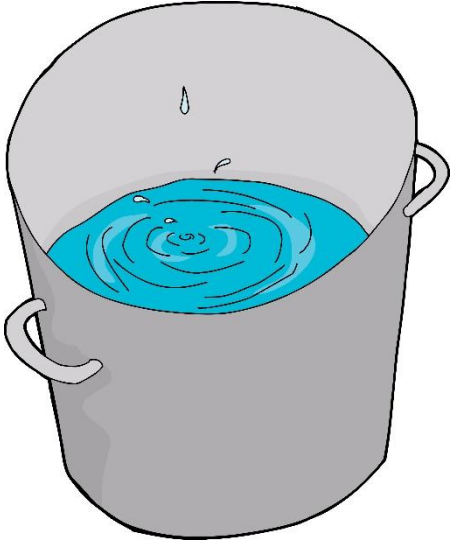

www.thisreadingmama.com

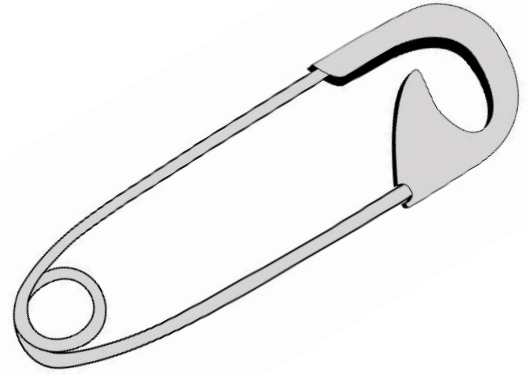

bin

pin



spin

win

Directions: Cut apart and match the words with the pictures.



www.thisreadingmama.com

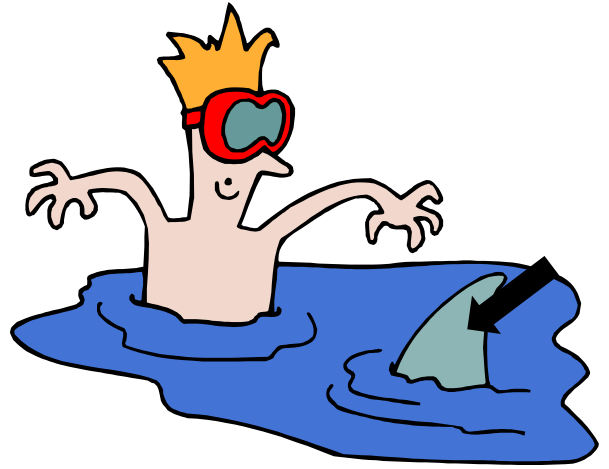

grin

fin

Bottle Cap Spelling

Use the pictures from the picture/word match for this activity.

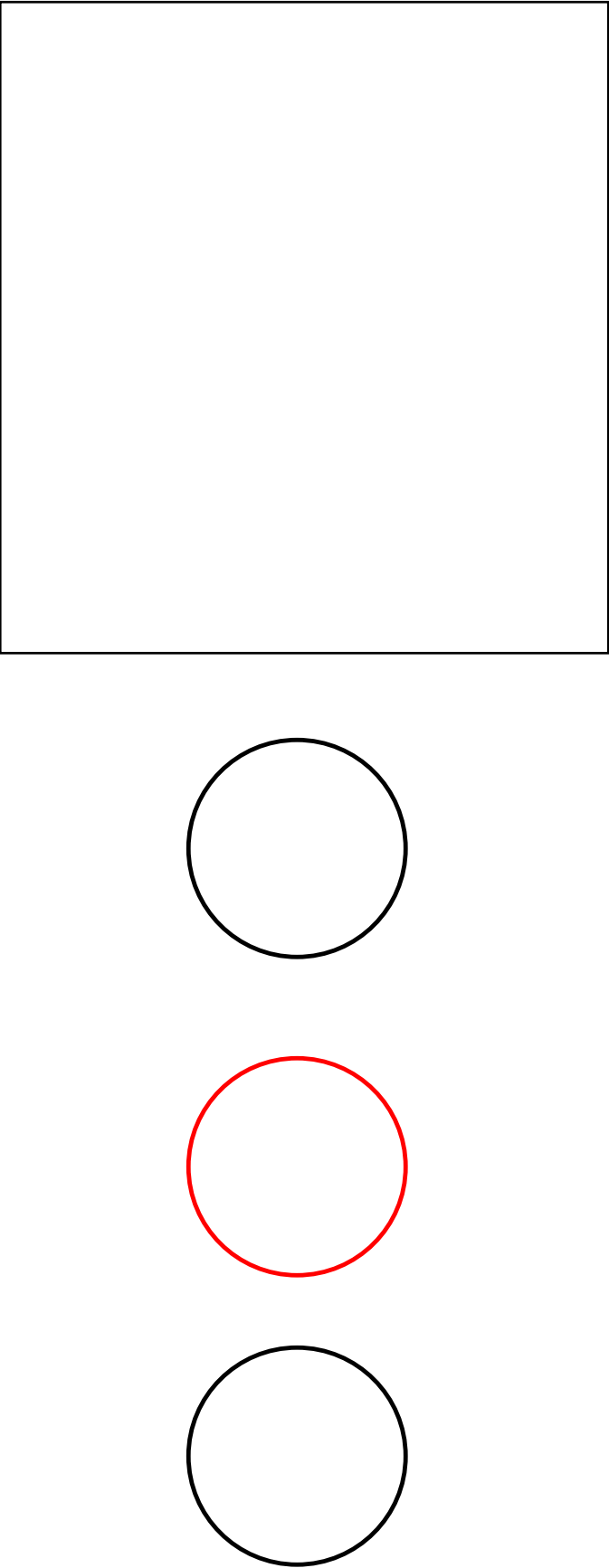

www.thisreadingmama.com

Directions:

*Gather bottle caps from water bottles or plastic soda bottles, write letters on the tops, and use them to spell the Word Family words. Use red tops for vowels, or write the vowels with red permanent marker.

*Print the Bottle Cap Spelling mat (1 for each student) & picture cards onto cardstock and laminate for durability.

To make this activity self-checking, write the word on the back of each laminated picture.

Word Family Spell a Word

Use the pictures from the picture/word match for this activity.

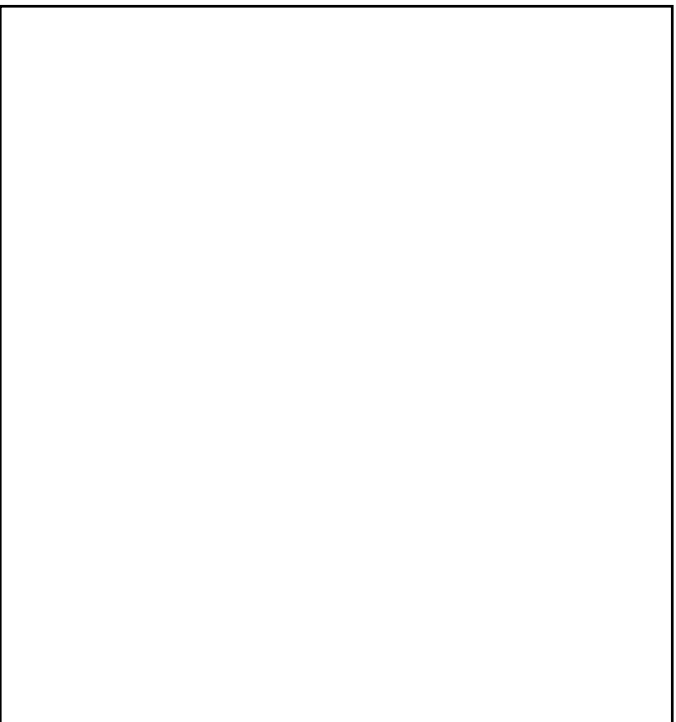

www.thisreadingmama.com

Three horizontal lines for writing the word: a solid top line, a dashed middle line, and a solid bottom line.

Directions:

*Place the picture card on the square. Then use the dotted lines for the student to write the word family words.

*Print the Bottle Cap Spelling mat (1 for each student) & picture cards onto cardstock and laminate for durability.

To make this activity self-checking, write the word on the back of each laminated picture.

Directions: Cut apart and match the words with the pictures.

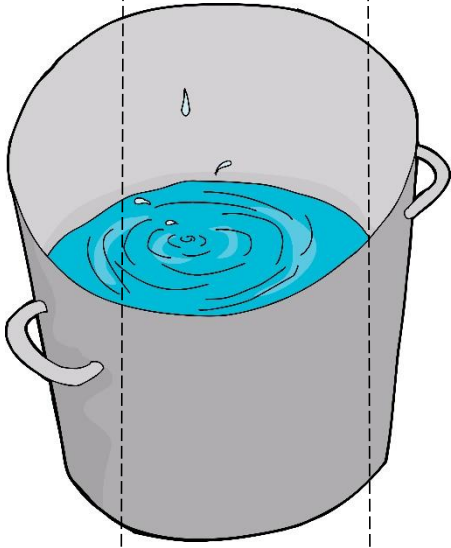

www.thisreadingmama.com

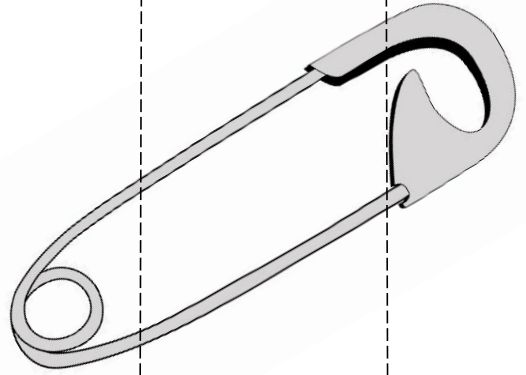

b i n

p i n

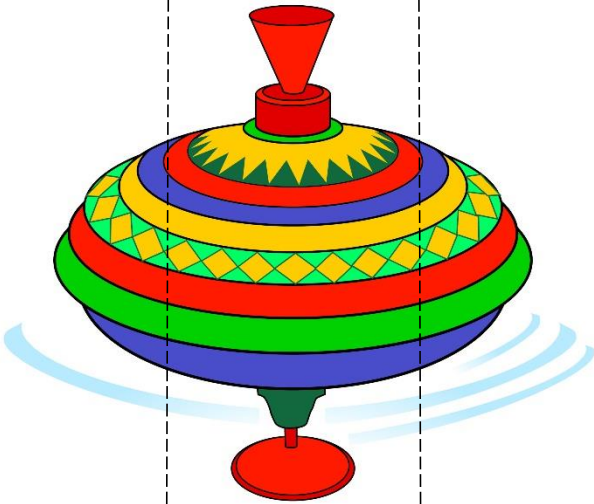

sp i n

w i n

Directions: Cut apart and match the words with the pictures.

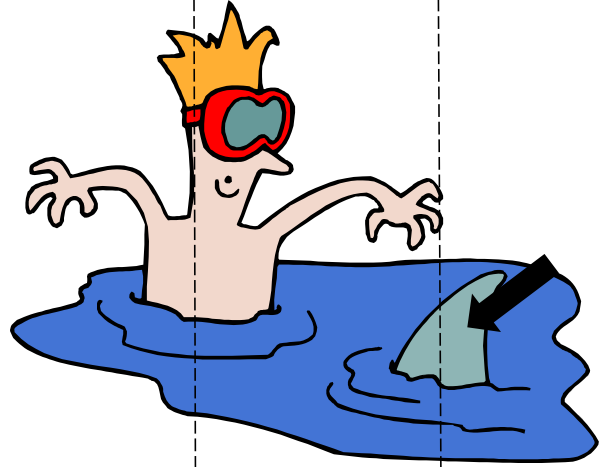
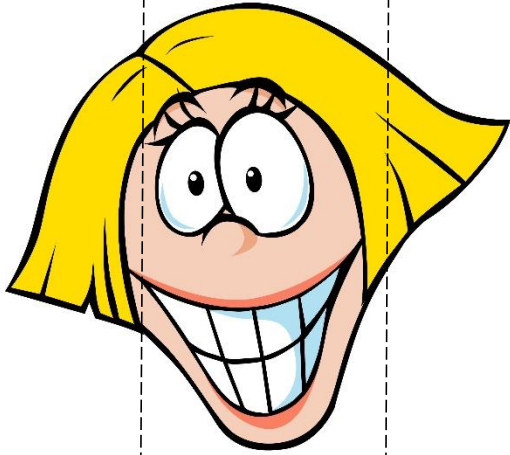

www.thisreadingmama.com

gr

i

n

f

i

n

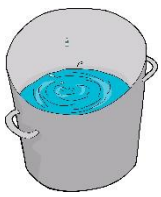

Word Family Sorting: Help Lin sort the words. Cut them out and place them on the mat. After you have sorted the words a few times, glue them down.

BOB Books Rhyming Words, Book 6: *Lin in the Bin*

IN Words

~~Not~~ IN Words

can

bin

grin

Lin

tip

has

and

spin

did

tin

fin

skip

Word Hunt

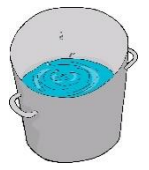

Directions: Find all the IN words in the sentences below.
(Students can dot, circle, underline, or highlight the words.)

Lin has a pin.

Lin can spin and spin.

The bin did tip on Lin.

Lin has a big grin.

Lin is in the bin.

You can win and grin.

The bin is tin.

The fin is in the bin.

Roll a Word

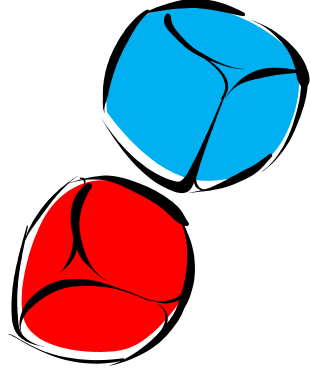

For use with education cubes. If you do not have education cubes, you can purchase them at www.amazon.com (they are called photo stacking blocks), make your own cubes with priority mail boxes, or adapt this activity without use of the cubes.

To Prep:

- Print onto cardstock for durability (you can also laminate inserts, but it's not necessary).
- Place all the onset cards (blue) into one cube and the rime inserts (red) in another cube.

To Play:

- The student rolls the onset cube, then rolls the rime cube.
- Slide the cubes side-by-side to "spell" each word. Example:
- Read each word made.
- As an extension, the student can use the Recording Sheet to write the rolled words. .

b

in



Onset Inserts

b

t

www.thisreadingmama.com

p

f

Onset Inserts

sp

gr

Rime Inserts

in

in

www.thisreadingmama.com

Rime Inserts

in

in

in

in

Roll a Word Recording Sheet

Write and illustrate the words you roll.

Flip a Word Directions

staple onset letters here

staple paper for pictures here

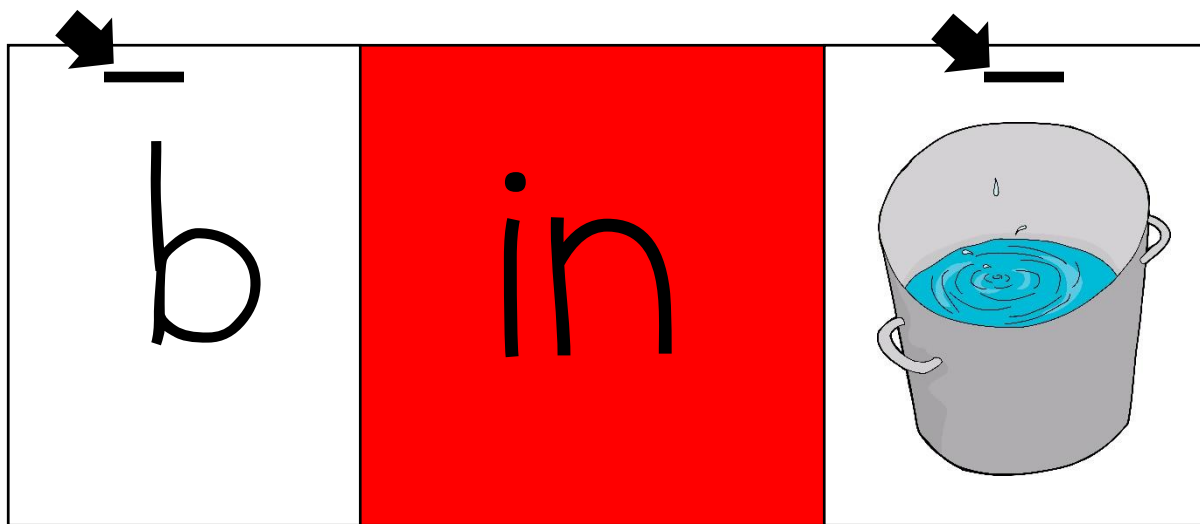

Write the onsets
on the papers
stapled above

Draw pictures of
the -in words on
the papers stapled
above

Directions:

Cut apart papers on the next few pages. Once papers are stapled into place, the student writes 6 different onsets (suggestions are on the bottom of the next page, such as *b*). Once the *in* is added, the student draws a picture that corresponds with the new word (*bin*) on the stapled paper on the right.

After all the words and pictures are finished, ask the student to flip through the chart and match the words to their pictures.

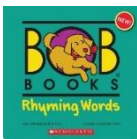



Onsets could include, but are not limited to: *b, f, gr, L, p, s, sp, t, & w*



Flip a Word Templates

Flip a Word Template:

Print onto cardstock.
Staple papers onto
this template.

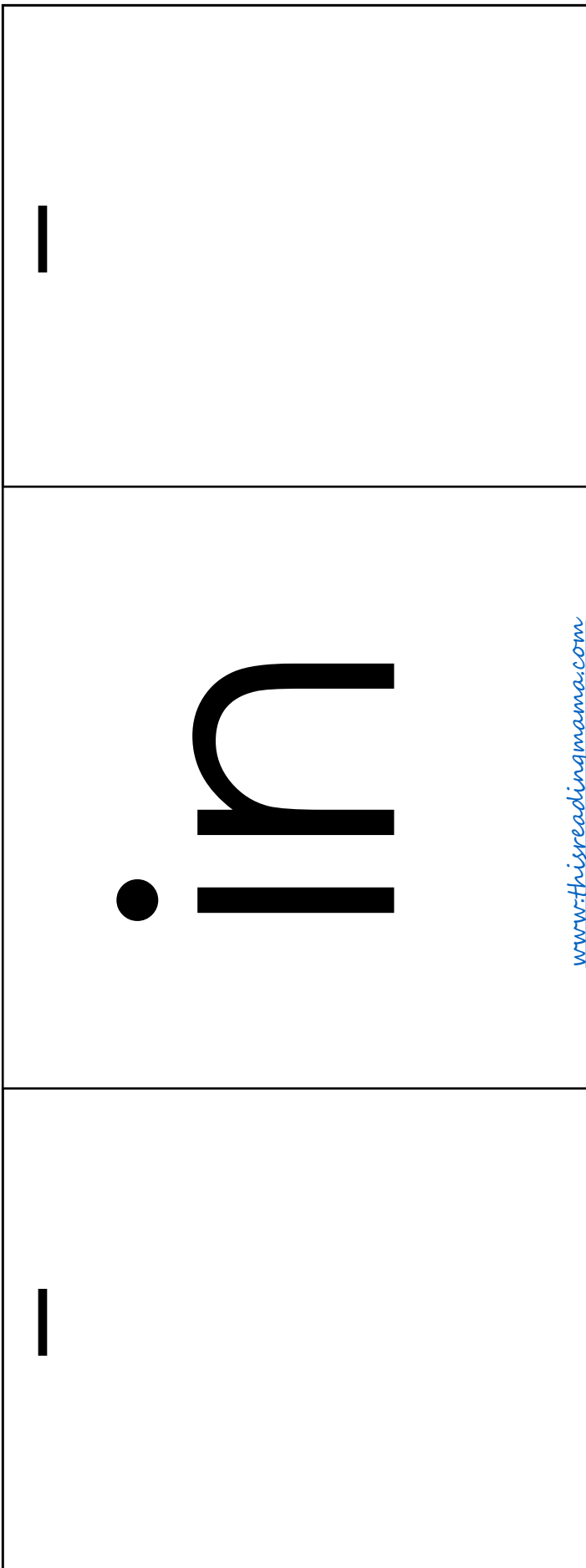

Can you find these words in the puzzle?

can

in

has

did

the

and

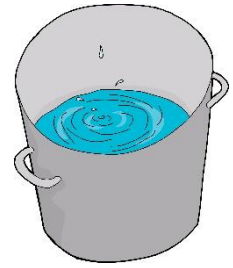

d	i	d	c	d	n	f	i
i	e	c	t	h	c	s	b
m	a	n	d	q	a	f	i
z	y	c	o	v	n	e	p
e	d	q	s	r	a	t	k
g	c	e	h	a	s	h	j
r	i	n	o	h	n	e	i
u	t	h	p	x	c	l	z

Place inserts into two separate dice. Players take turns rolling the dice and reading the words they have rolled. If the words match (such as *can/can*), the player gets to write the matching word on the recording sheet. The first player to write all six words first wins.

1st die inserts

can

in

www.thisreadingmama.com

did

the

has

and

can

in

www.thisreadingmama.com

1st die inserts

2nd die inserts

2nd die inserts

did

the

has

and

If you roll a match, write the word in one of the spaces. When you have written all six words, you win!



IN Word Family BINGO!

tin

spin

fin

Lin



FREE Space

bin

win

thin

chin

IN Word Family BINGO!

Lin

skin

pin

grin



FREE Space

thin

fin

tin

spin

IN Word Family BINGO!

fin

spin

tin

win



FREE Space

Lin

bin

twin

skin

IN Word Family BINGO!

spin

tin

chin

pin



FREE Space

win

skin

fin

grin

BINGO Directions: Print and cut out cards. Place them in a pile face down. Players take turns drawing a card and reading the word. All players look for the word on their board and cover it if they have it. The first player to get three in a row wins.

tin

Lin

bin

pin

win

fin

spin

grin

thin

chin

skin

twin